

PA8

8 Channel Power Amplifier



Fill in for your records:

Serial Number:

Purchase Date:



Introduction

The PA8 8 Channel Power Amplifier is a unique single rack-space solution for zoned, distributed loudspeaker systems with eight separate power amplifiers, each with an output power capability of 10W (4 Ohms) or 6W (8 Ohms.)

The PA8 is passively cooled, and features full short-circuit and thermal overload protection. The amplifier outputs are muted at turn-on and turn-off to eliminate transients

Contents

Introduction.....	2
Contents	3
General Technical Description.....	4
Bridged Output	4
Front Panel Description.....	5
REAR PANEL DESCRIPTION.....	5
Operation Note	5
Troubleshooting.....	6
SYMPTOM	6
POSSIBLE CAUSE	6
Specifications	6
Service and Repair.....	7
Returning Units for Repair.....	7

General Technical Description

The PA8 uses a straightforward, low parts count design for long term reliability. The heart of the power supply is a low radiation toroidal transformer. The toroidal transformer generates less heat than a comparable non-toroidal type, and emits considerably less 60Hz energy. This is particularly important when the PA8 is used in close proximity to microphone preamplifiers. The input to the PA8 is fully balanced and RF filtered. The level control feeds a monolithic power amplifier. Each power amplifier is internally power limited to protect itself from short circuits, excessively low impedances, or highly reactive loads. Thermal limiting is also integrated into the power amplifier, with an intelligent shutdown mode that minimizes thermal shock to the device under extreme operation. Any two channels may be used in the bridged mode for higher power (20W/8 Ohms or 12W/16 Ohms).

The block diagram of the PA8 is shown below.

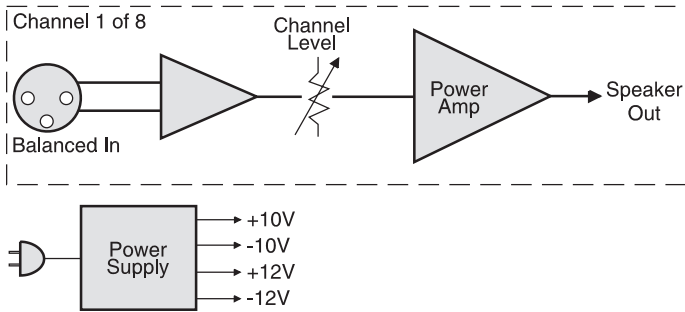

Figure 1 - PA8 Block Diagram

Installation

Installing the PA8 properly is simple, and only requires attention to a few issues. The PA8 should be used in a grounded metal rack. One open rack space should be provided above and below the PA8 for proper ventilation.

Non-Bridged Output

The standard PA8 configuration would have a balanced output device (like the MM8 Matrix Mixer) driving each channel of the PA8. The speaker is connected in the non-bridged mode. Maximum output power is 10W into 4 Ohms, or 6W into 8 Ohms.

Figure 2 shows this configuration.

When driving the PA8 with an unbalanced source, the (-) terminal is connected to the ground of the driving signal, as well as the ground terminal of the PA8 input.

Figure 3 shows this configuration.

Bridged Output

Two adjacent channels of a PA8 may be connected as shown in Figure 4 to allow bridging operation. In the bridged mode, the minimum speaker load is 8 Ohms, and maximum power output is 20W into 8 Ohms. Note that since the Channel Level controls of both bridged channels will be active, they should be set to the same level. The loudspeaker is connected to the “+” output terminals of each channel, while the “-” outputs are left unconnected.

Figure 5 shows bridging operation using an unbalanced source.

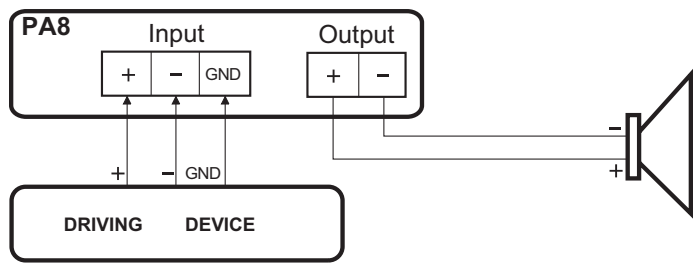

Figure 2 - Balanced Input / Non-Bridged Output

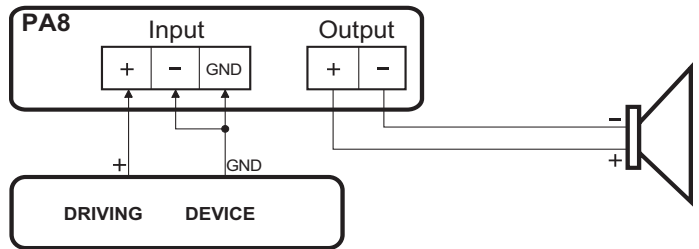

Figure 3 - Unbalanced Input / Non-Bridged Output

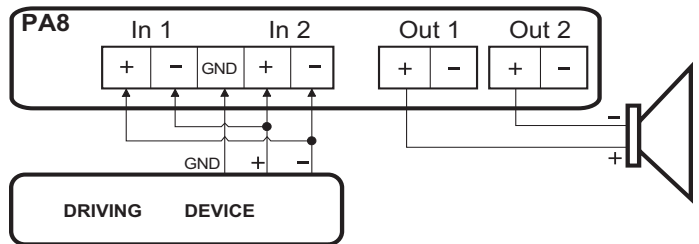

Figure 4 - Balanced In / Bridged Out

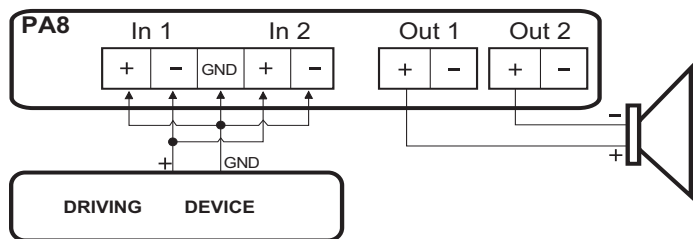

Figure 5 - Unbalanced In / Non-Bridged Out level is reached

Front Panel Description

POWER SWITCH - Turns AC power on and off.

POWER LED - Indicates the presence of AC power to the PA8.

CHANNEL LEVEL 1-8 - Controls the volume level of each channel.

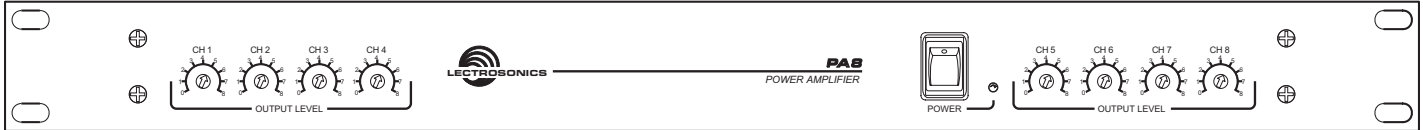

Figure 6 - PA8 Front Panel

REAR PANEL DESCRIPTION

LINE INPUTS 1-8 - Accepts balanced or unbalanced signal. Fully balanced differential input, RF filtered.

SPEAKER OUTPUTS 1-8 - Drive minimum 4 Ohm loads non-bridged, and minimum 8 Ohm loads bridged.

AC POWER RECEPTACLE - Accepts standard detachable 120VAC power cord.

AC POWER FUSE - Accepts a 3A, 250V (1.5A, 250V when wired for 230VAC operation) Slo-Blo fuse.

Figure 6 - PA8 Front Panel

Figure 7 - PA8 Rear Panel

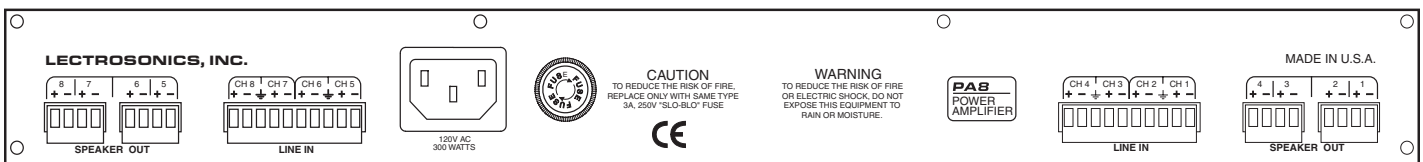

Operation Note

Remember that the PA* expects a loudspeaker load without a matching transformer at the speaker.

Troubleshooting

SYMPTOM

No sound from system

POSSIBLE CAUSE

- 1) Channel Level control not turned up
- 2) Channel input incorrectly wired
- 3) Power switched off
- 4) Fuse may be blown

Specifications

Line Input

Type:	Electronically balanced and RF filtered 20k Ohms, Balanced or Unbalanced
Impedance:	-2dBu (615mVRMS) at maximum level +15dBu (4.36VRMS) at mid level
Input Level for Rated Output:	10 Watts into 4 Ohms, 6 Watts into 8 Ohms 20 Watts into 8 Ohms with bridged monoconfiguration
Output Power:	4 Ohms minimum
Output impedance:	
Maximum System Gain	
Line Input to Speaker Out:	20dB (x10)

Signal-to-Noise Ratio:	88dB relative to 10W at 4 Ohms
System THD:	Less than 0.1%, 20Hz to 20kHz (10W into 4 Ohms)
System IMD:	Less than 0.1%, 60Hz/7kHz (10W into 4 Ohms)
Slew Rate:	12V/uS
Power Consumption:	200 Watts max at 120VAC 200 Watts max at 230VAC
Weight:	8 lbs, 9 ozs
Dimensions:	19" wide x 1.3/4" high x 8 1/4" deep

*Euro version, I-PA8 is CE marked and runs on 220VAC.

Specifications subject to change without notice

Service and Repair

If your system malfunctions, you should attempt to correct or isolate the trouble before concluding that the equipment needs repair. Make sure you have followed the setup procedure and operating instructions. Check the interconnecting cables and then go through the **Troubleshooting** section in this manual.

We strongly recommend that you **do not** try to repair the equipment yourself and **do not** have the local repair shop attempt anything other than the simplest repair. If the repair is more complicated than a broken wire or loose connection, send the unit to the factory for repair and service. Don't attempt to adjust any controls inside the units. Once set at the factory, the various controls and trimmers do not drift with age or vibration and never require readjustment. **There are no adjustments inside that will make a malfunctioning unit start working.**

LECTROSONICS' Service Department is equipped and staffed to quickly repair your equipment. In warranty repairs are made at no charge in accordance with the terms of the warranty. Out-of-warranty repairs are charged at a modest flat rate plus parts and shipping. Since it takes almost as much time and effort to determine what is wrong as it does to make the repair, there is a charge for an exact quotation. We will be happy to quote approximate charges by phone for out-of-warranty repairs.

Returning Units for Repair

For timely service, please follow the steps below:

- A.** DO NOT return equipment to the factory for repair without first contacting us by email or by phone. We need to know the nature of the problem, the model number and the serial number of the equipment. We also need a phone number where you can be reached 8 A.M. to 4 P.M. (U.S. Mountain Standard Time).
- B.** After receiving your request, we will issue you a return authorization number (R.A.). This number will help speed your repair through our receiving and repair departments. The return authorization number must be clearly shown on the **outside** of the shipping container.
- C.** Pack the equipment carefully and ship to us, shipping costs prepaid. If necessary, we can provide you with the proper packing materials. UPS is usually the best way to ship the units. Heavy units should be "double-boxed" for safe transport.
- D.** We also strongly recommend that you insure the equipment, since we cannot be responsible for loss of or damage to equipment that you ship. Of course, we insure the equipment when we ship it back to you.

Lectrosonics USA:

Mailing address:

Lectrosonics, Inc.
PO Box 15900
Rio Rancho, NM 87174
USA

Shipping address:

Lectrosonics, Inc.
581 Laser Rd.
Rio Rancho, NM 87124
USA

Telephone:

(505) 892-4501
(800) 821-1121 Toll-free
(505) 892-6243 Fax

Web:

www.lectrosonics.com

E-mail:

sales@lectrosonics.com

Lectrosonics Canada:

Mailing Address:

49 Spadina Avenue,
Suite 303A
Toronto, Ontario M5V 2J1

Telephone:

(416) 596-2202
(877) 753-2876 Toll-free
(877-7LECTRO)
(416) 596-6648 Fax

E-mail:

Sales: colinb@lectrosonics.com
Service: joeb@lectrosonics.com

LIMITED ONE YEAR WARRANTY

The equipment is warranted for one year from date of purchase against defects in materials or workmanship provided it was purchased from an authorized dealer. This warranty does not cover equipment which has been abused or damaged by careless handling or shipping. This warranty does not apply to used or demonstrator equipment.

Should any defect develop, Lectrosonics, Inc. will, at our option, repair or replace any defective parts without charge for either parts or labor. If Lectrosonics, Inc. cannot correct the defect in your equipment, it will be replaced at no charge with a similar new item. Lectrosonics, Inc. will pay for the cost of returning your equipment to you.

This warranty applies only to items returned to Lectrosonics, Inc. or an authorized dealer, shipping costs prepaid, within one year from the date of purchase.

This Limited Warranty is governed by the laws of the State of New Mexico. It states the entire liability of Lectrosonics Inc. and the entire remedy of the purchaser for any breach of warranty as outlined above. NEITHER LECTROSONICS, INC. NOR ANYONE INVOLVED IN THE PRODUCTION OR DELIVERY OF THE EQUIPMENT SHALL BE LIABLE FOR ANY INDIRECT, SPECIAL, PUNITIVE, CONSEQUENTIAL, OR INCIDENTAL DAMAGES ARISING OUT OF THE USE OR INABILITY TO USE THIS EQUIPMENT EVEN IF LECTROSONICS, INC. HAS BEEN ADVISED OF THE POSSIBILITY OF SUCH DAMAGES. IN NO EVENT SHALL THE LIABILITY OF LECTROSONICS, INC. EXCEED THE PURCHASE PRICE OF ANY DEFECTIVE EQUIPMENT.

This warranty gives you specific legal rights. You may have additional legal rights which vary from state to state.



581 Laser Road NE • Rio Rancho, NM 87124 USA • www.lectrosonics.com
(505) 892-4501 • (800) 821-1121 • fax (505) 892-6243 • sales@lectrosonics.com

May 18, 2009